

PanelPilotACE

SGD 43-A-RTC | Quick Start Guide



PanelPilotACE

SGD 43-A-RTC

Quick Start Guide

Introduction

Thank you for purchasing the SGD 43-A-RTC Runtime Counter App. This guide will help you set-up the standard App supplied with your SGD-43-A display. If you want to adapt and customise the Runtime Counter App, this can be done using the PanelPilotACE Design Studio. This software is free and available from:

www.lascarelectronics.com/software/panelpilot-software/panelpilotace-design-studio.

Alternatively, contact us and we will be more than happy to discuss your customisation requirements.



1. Welcome

The runtime application starts with a Welcome Screen and the 'Next' arrow button will appear.

Press 'Next' to continue.



Fig.1 Welcome Screen

Next Button

2. Create a new PIN

You will be asked to create a 4-digit security PIN that you can enter using the keypad. The PIN restricts access to the settings area of the App. You will need to enter this to change settings after the initial set-up is complete.

You will then be prompted to confirm the 4-digit PIN.

Note: If you fail to confirm the PIN four times in a row, you will be sent back to the PIN creation screen.



Fig.2 Create and Confirm Screens

3. Set Trigger

After PIN creation you will then be asked to set your trigger type and values. This will initiate the Runtime Counter to activate when it reaches a threshold.

There are two options. One is to set a Voltage Theshold using the + - buttons (the default is set as 5.0V). The second is to select Active Polarity as either High or Low. See the Wiring and Customisation section on page 9 for more information.

Next, a pop-up will appear for you to confirm you are happy with your trigger set up.

Note: If the voltage value is already within the range you have set, upon confirmation, the Runtime Counter will start.

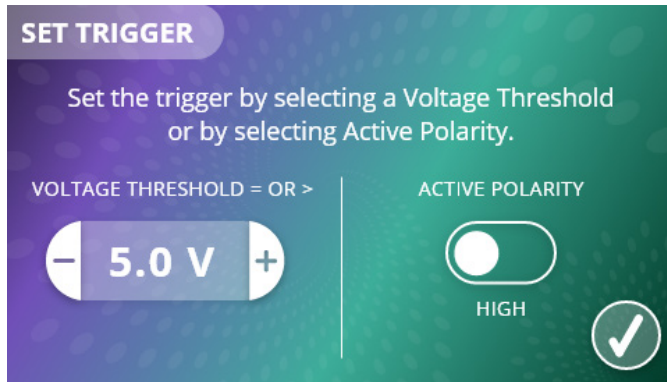

Fig.3 Set Trigger Screen



Fig.4 Trigger Confirmation Screen (Voltage Threshold)

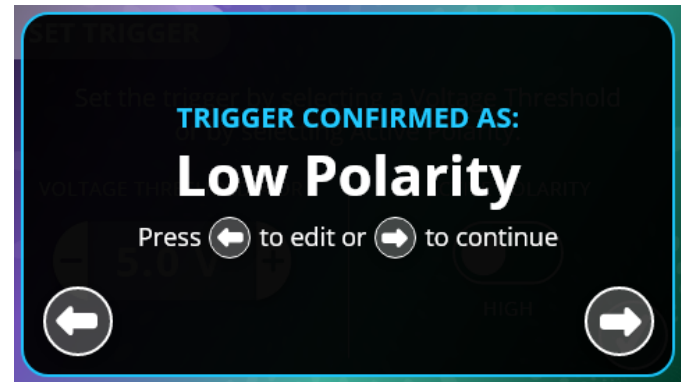

Fig.5 Trigger Confirmation Screen (Active Threshold)

4. Select Schedule Type

Once the Trigger Type is set, you will then be able to set your timer schedules in the Select Schedule Type menu. Choose from Maintenance, Cleaning, or Calibration by clicking on one of the circular icons.

Under the icons you will see the current timer setting. If the Runtime Counter has not been set up before, then these values will show as NA (see Fig. 6). If set up previously, or already running, then the Current Settings values will display here (see Fig. 7).

From this screen you can also Factory Reset the device by selecting the 'Reset' icon in the top right corner.

Note: Factory Reset will erase all previous settings and reset the runtime counter.

From this screen, you also have the option to return to the Runtime Counter via the 'Runtime' button, or go to the Display Settings screen by pressing the 'Display Settings' button.

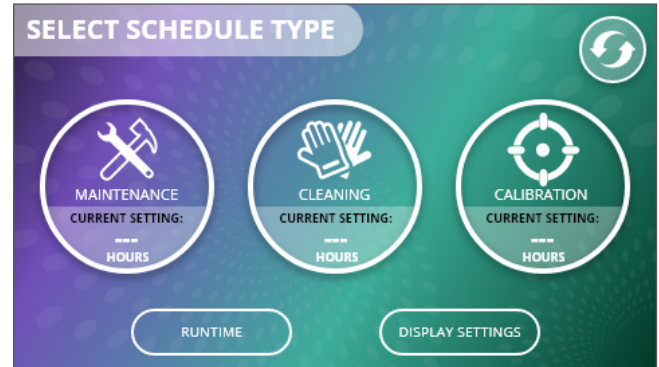

Fig.6 Select Schedule Type Screen (1st time setup)

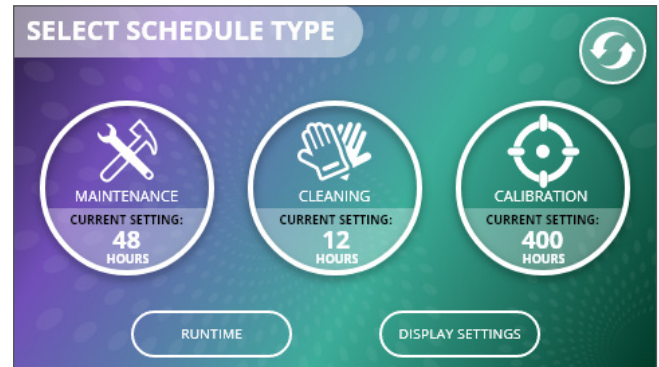

Fig.7 Select Schedule Type Screen (If previously set up or currently running)

5. Set Schedules

Once a Schedule has been selected the corresponding settings screen will display. Each schedule type is initially set to disabled on first use (See Fig. 8). Press the toggle button to switch from Disabled to Enabled. The keypad is now accessible to type in the runtime required (See Fig. 9).

Press the tick icon and then the Confirm popup screen will display. Select confirm or the back arrow button to cancel (See Fig.10).

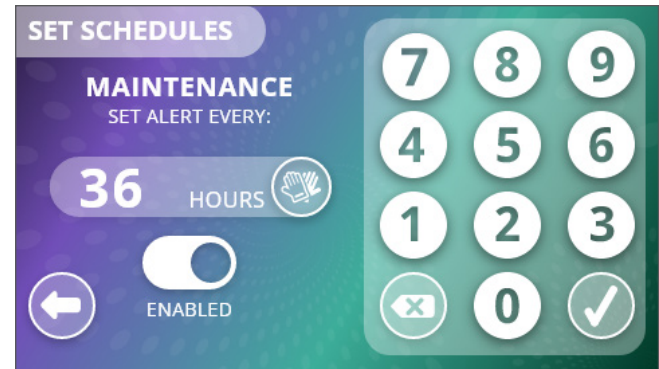

Fig.9 Set Schedule Screen - Maintenance (Enabled)

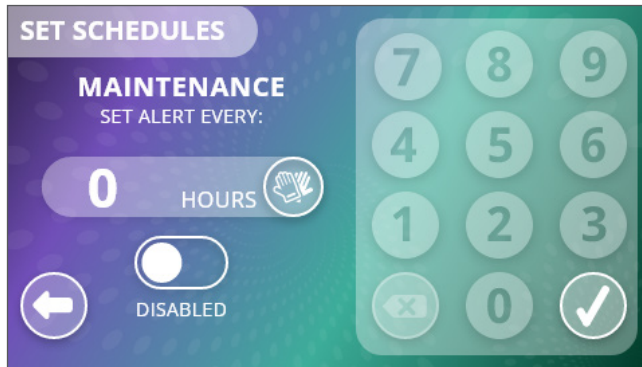

Fig.8 Set Schedule Screen - Maintenance (Default Disabled)

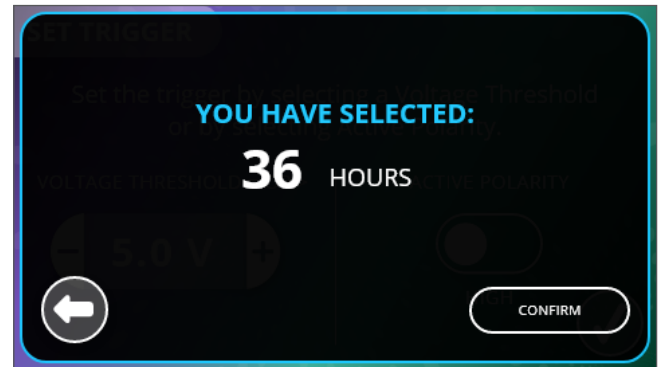

Fig.10 Set Schedule Confirmation Screen

6. Display Settings

The Display Settings screen allows you to setup a display sleep timer. This will turn the screen off after it has not been active for a specified time. If "OFF" is selected, then the screen will be permanently on.

The display style can also be set with either a light or dark background (See Fig. 11 and 12).

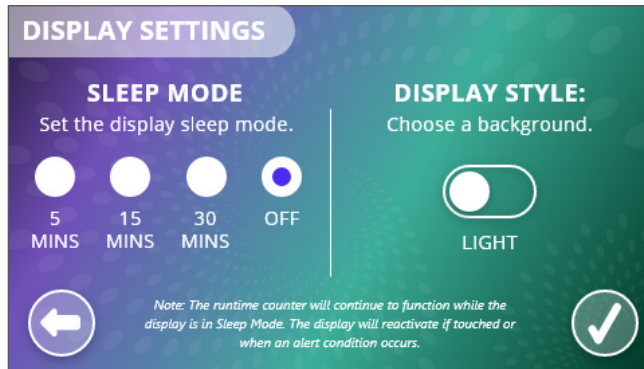

Fig. 11 Display Settings Screen in Light Mode

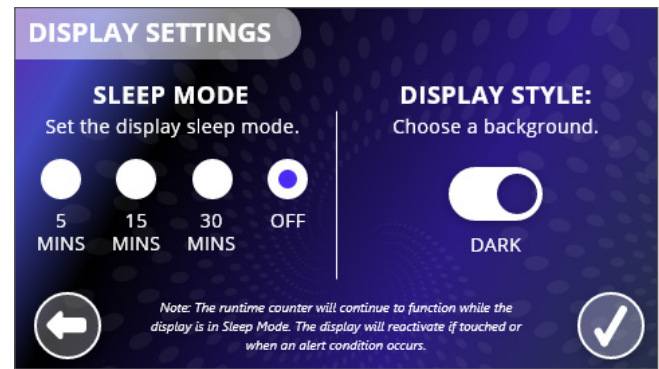

Fig. 12 Display Settings Screen in Dark Mode

7. Runtime Counter

The 'Runtime' screen is the main display once set up is complete. You can view how long your counter has been running for as well as the countdown until each of your pre-set schedules is complete (activating the alarm modes).

Return to the 'Schedule Settings' menu via the cog icon the lower right corner of the screen.

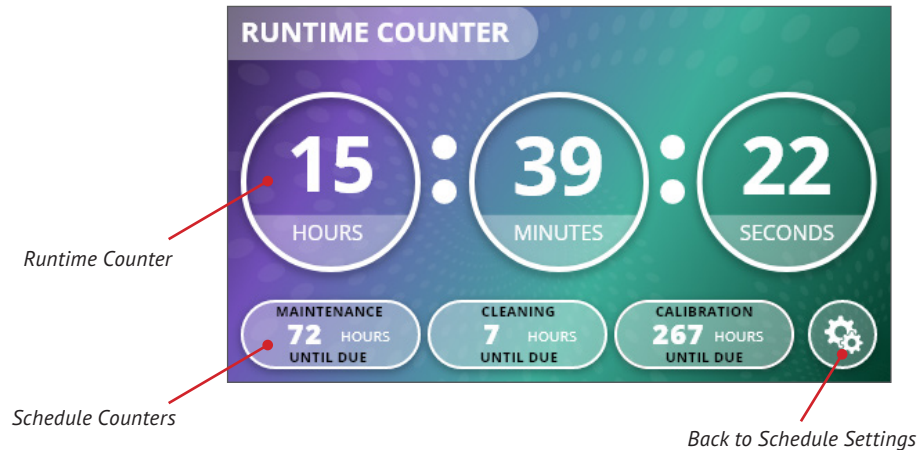

Fig. 13 Main Runtime Counter Screen

8. Alarms

At 80% of your schedule setting, the schedule type will be surrounded by an amber border as a visual alert (See Fig.14).

At 90% of your schedule setting, the digital output will be triggered and a red background will fill the service type (See Fig.15).

At 100% a pop-up will show that you have reached your alert threshold as well as triggering digital output (See Fig.16).

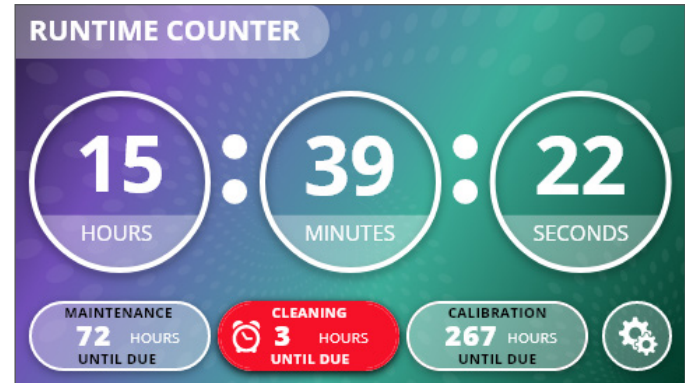

Fig.15 90% Red Alarm Alert



Fig.14 80% Amber Alarm Alert

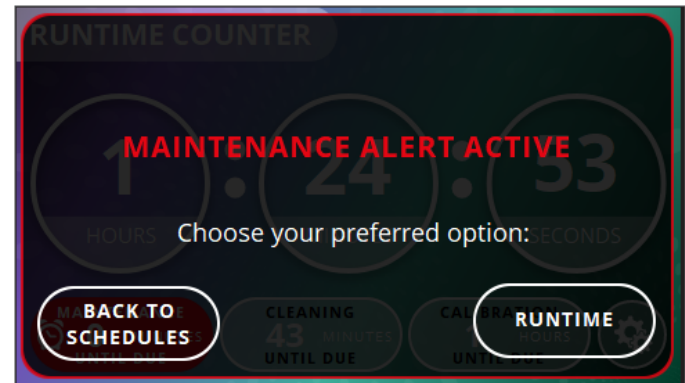

Fig.16 100% Pop-up Alarm Alert

9. Wiring and Customisation

Active Trigger Input

The Active voltage trigger is applied to IN1 on TBLK1 pin 6 or PL11 pin 1. The required voltage level for the trigger is set by the user during the initial power-up of the Runtime Counter. For Volt Free Contact operation as shown in the below application, the Trigger voltage level should be set higher than 1V and less than the V+ supply on Pin 1 of TBLK1. In addition the trigger can be set to be Active when the Input is either High or Low.

Trigger Signal Examples

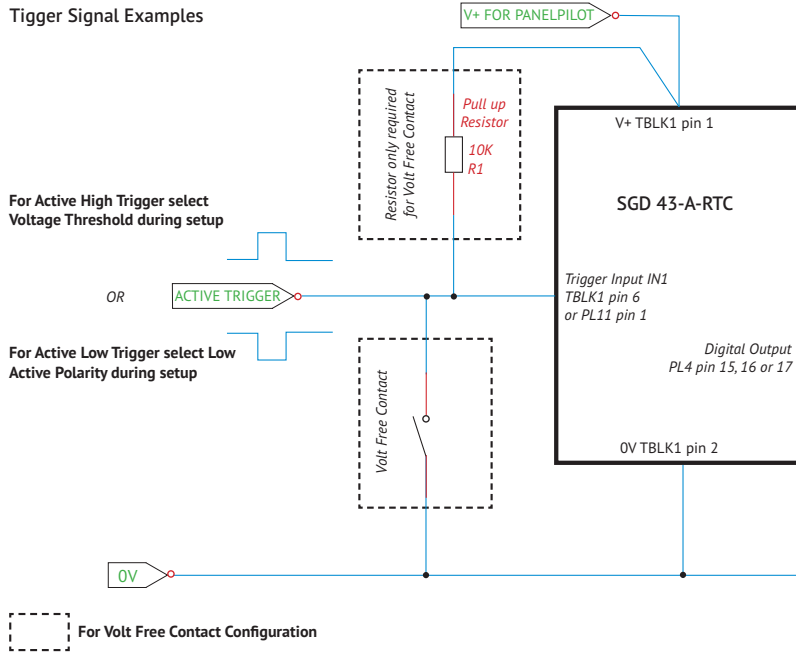

Example for driving a Relay from a Digital Output

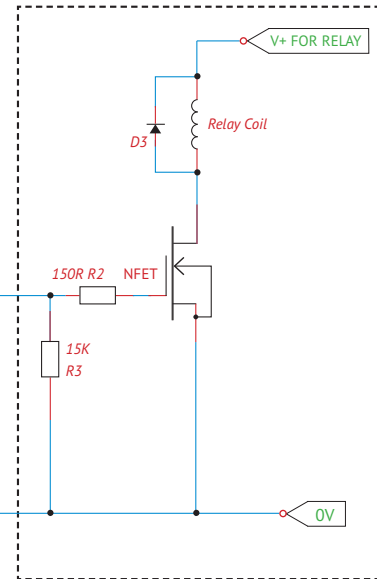

**Contact Lascar Electronics
Technical Support for advice
on other configurations and
further assistance.**

PanelPilotACE

SGD 70-A-RTC | Quick Start Guide

Contact us for more
PanelPilotACE products,
services and support:

UK & Europe

www.lascarelectronics.com
sales@lascar.co.uk
+44(0)1794 884567

Americas

www.lascarelectronics.com
us-sales@lascarelectronics.com
(814) 835 0621

Asia

www.lascarelectronics.com
saleshk@lascar.com.hk
+852 2389 6502



PanelPilotACE
SGD 43-A-RTC QSG
Issue 1 09/2020

www.lascarelectronics.com