

UNO-348

**Compact Embedded Edge Controller
with 10th Gen Intel® Processor, up to
3 x PCIe/PCI slots, 1 x M.2 B-Key,
1 x mPCIe, and 2 x 2.5" SSD**

NEW



UNO-348-AXX1A

UNO-348-AXX3A



Features

- 10th gen Intel® socket-type processor with DDR4 memory
- Scalable processor and RAM memory options
- Compact, rugged, fanless design for harsh embedded environments
- Flexible expansion with up to 3 x PCIe/PCI slots, 1 x M.2 (B-key), 1 x mPCIe, and 2 x 2.5" SSD
- Optional iDoor expansion
- Remote out-of-band (OOB) power management with Advantech's iBMC technology
- Built-in TPM2.0 for hardware-based security

Introduction

UNO-348 is a high-performance, fanless, embedded edge controller equipped with a 10th gen. Intel® Core™ i5/i9 processor with 8/16 GB DDR4 memory and Intel® H420E PCH chipset. Despite its compact size, UNO-348 offers multiple I/O including 4 x USB 3.2, 2 x USB 2.0, 3 x GigaLAN, 2 x RS-232/422/485, and 1 x RS-232 ports, as well as 1 x Line-out, 1 x Mic-in, 1 x DisplayPort, and 1 x HDMI interfaces. Designed to deliver high-performance computing and maximum flexibility for industrial automation applications, UNO-348 also features 2 x internal HDD/SSD bays, 1 x full-size mPCIe, 1 x M.2 B-key, and up to 3 x PCIe/PCI expansion slots (1 x PCIe x16, 2 x PCI) to support the integration of optional peripherals. In addition to dual power inputs that ensure a stable power supply, UNO-348 is equipped with Advantech's iBMC technology to support remote OOB power management to reduce system downtime and operational costs.

Specifications

General

- **Certification** CB/UL, CE/FCC Class A, CCC, BSMI
- **Dimensions (W x D x H)** UNO-348-AXX1A: 200 x 140 x 120 mm/7.8 x 5.5 x 4.7 in
UNO-348-AXX3A: 200 x 140 x 160 mm/7.8 x 5.5 x 6.3 in
- **Form Factor** Regular
- **Mounting** Wall, stand
- **Weight (Net)** UNO-348-AXX1A: 3.5 kg/7.7 lb
UNO-348-AXX3A: 4 kg/8.8 lb
- **Power Requirements** 10 ~ 36 V_{DC}
Note: Power should be fixed at 24V_{DC} (± 20%) when total power consumption exceeds 160W.
- **Power Consumption** 59W (typical), 100W (Max)
When equipped with PCI/PCIe card:
UNO-348-AXX1A: up to 174.1W
UNO-348-AXX3A: up to 224.1W
Note:
PCIex16 slot supports up to 75W
PCIex4 slot supports up to 25W
PCIex1 slot supports up to 10W
PCI slot supports up to 25W
- **OS Support** Win 10 2019 LTSC, AdvLinux (Ubuntu 18.04)

Hardware

- **BIOS** AMI UEFI (128 Mbit)
- **Hardware Security** TPM2.0
- **Watchdog Timer** Programmable timer with 255 intervals (1 ~ 255 sec)
- **Processor*** Intel® Core™ i5-10500TE, 2.3 GHz, 6 cores
Intel® Core™ i9-10900TE, 1.8 GHz, 10 cores
Intel® H420E (W480E available upon request)
- **Chipset** i5 CPU: Built-in 8 GB DDR4, 2933 MHz, dual sockets support up to 64 GB
i9 CPU: Built-in 16 GB DDR4, 2933 MHz, dual sockets support up to 64 GB
- **Memory*** Intel HD Graphics
- **Graphics Engine** LAN A: Intel® i211-AT GbE, IEEE 802.3AZ/802.1AS
LAN B: Intel® i210-AT GbE, IEEE 802.3AZ/802.1AS (Support iBMC)
- **Ethernet** LAN C: Intel® i219-LM GbE, IEEE 802.3AZ/802.1AS

- **LED Indicators** 1 x Programmable LED, 1 x power LED, 1 x HDD LED, and 1 x LAN (active, status)
- **Storage/Expansion** 2 x 2.5" SSD/HDD bay
1 x M.2 B key (SATA/ USB 3.0 signal) for 2242/2280 SATA SSD or 3042/3052 LTE/5G module expansion
1 x Full-size mPCIe (PCIe/ USB2.0 signal)
UNO-348-AXX1A: 1 x PCIe x16,
UNO-348-AXX3A: 1 x PCIe x16, 2 x PCI

I/O

- **Serial Ports** 2 x RS-232/422/485, 1 x RS-232. 50bps ~ 115.2 kbps (DB9)
- **LAN Ports** 3 x RJ45, 10/100/1000 Mbps IEEE 802.3u 1000BASE-T Fast Ethernet
- **USB Ports** 4 x USB 3.2 Gen 1, 2 x USB 2.0 (Type A)
- **Displays** 1 x DP 1.4, supports 4096 x 2304 @ 60Hz (DP++)
1 x HDMI 1.4, supports 4096 x 2160 @ 30Hz
- **Audio** Mic-in, Line-out (Line-out can be configured as Line-in upon request)
- **Power Connector** 1 x 4-pin terminal block
- **Remote Power Control** 1 x 2-pin terminal block that supports remote Power On/Off function (can support remote reset function via jumper settings)
- **GPIO** 1 x GPIO (8 bit) internal pin header

Environmental

- **Operating Temperature** -20 ~ 50 °C/-4 ~ 122 °F with 0.7m/s airflow and wide-temperature (-40 ~ 85 °C/-40 ~ 185 °F) peripherals, e.g., SSDs, wireless modules
- **Storage Temperature** -40 ~ 85 °C/-40 ~ 185 °F
- **Relative Humidity** 95% RH @ 40 °C/104 °F, non-condensing
- **Shock Protection** Operating, IEC 60068-2-27, 50G, half sine, 11ms
- **Vibration Protection** Operating, IEC 60068-2-64, 4 Grms, random, 5 ~ 500 Hz, 1hr/axis (SSD)
- **Ingress Protection** IP20

*The processor and memory can be flexibly configured. See ordering information for more details.

Installation Options

Stand mount



Wall mount

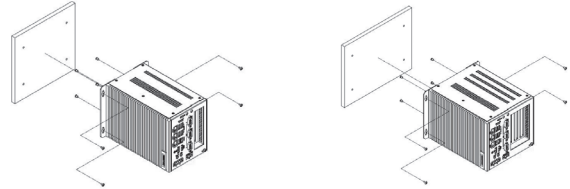

Note: Mount kit included with product as a default.

Dimensions

Unit: mm

UNO-348-AXX1A

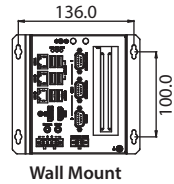
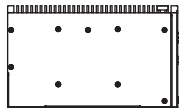
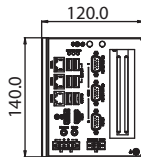
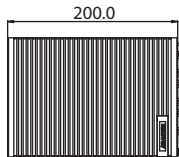
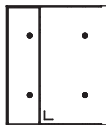
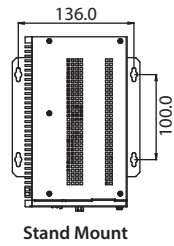
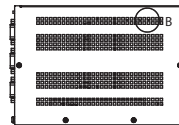
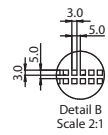
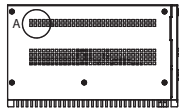
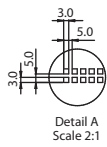

UNO-348-AXX3A

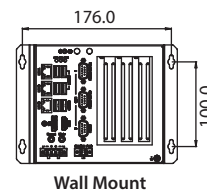
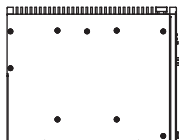
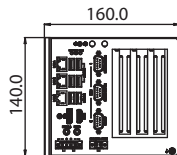
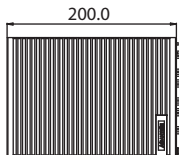
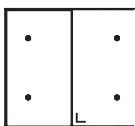
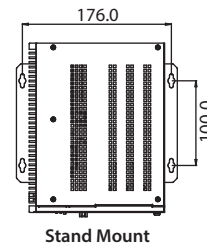
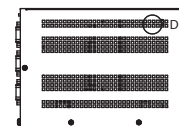
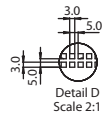
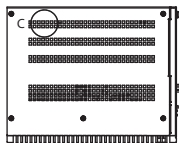
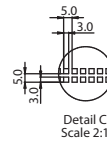

I/O View

UNO-348-AXX1A

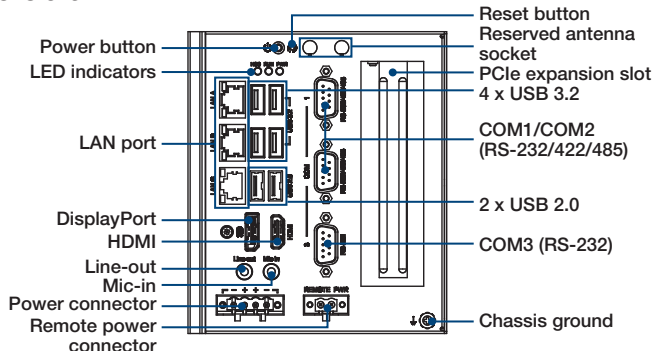

UNO-348-AXX3A

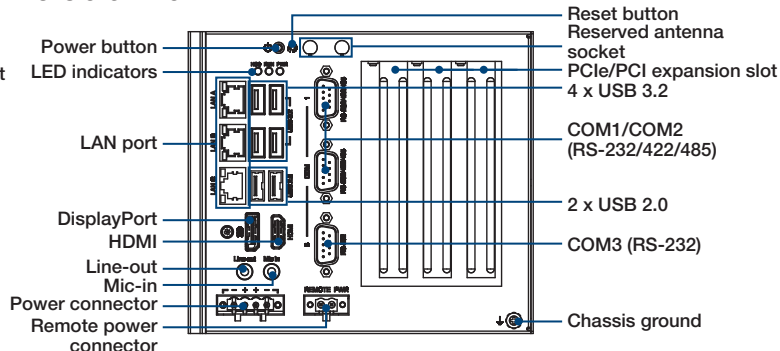

Ordering Information

Part Number	Description	CPU	PCH	RAM	Number of PCIe/PCI Slots
UNO-348-A531A	Intel® Core™ i5-10500E 6-core CPU, Intel® H420E chipset, 8 GB RAM, 3 x COM, 6 x USB, 3 x LAN, 1 x PCIe x16	Intel® Core™ i5-10500TE	H420E	8 GB	1 x PCIe x16
UNO-348-A941A	Intel® Core™ i9-10900E 10-core CPU, Intel® H420E chipset, 16 GB RAM, 3 x COM, 6 x USB, 3 x LAN, 1 x PCIe x16	Intel® Core™ i9-10900TE		16 GB	
*UNO-348-ANN1A	Intel® H420E chipset, 3 x COM, 6 x USB, 3 x LAN, 1 x PCIe x16	Optional. (Supports Intel® Core™ i9/i7/i5/i3/ Celeron®/Pentium®)		Optional support up to 64 GB	
UNO-348-A533A	Intel® Core™ i5-10500E, 6-core CPU, Intel® H420E chipset, 8 GB RAM, 3 x COM, 6 x USB, 3 x LAN, 1 x PCIe x16, 2 x PCI	Intel® Core™ i5-10500TE	H420E	8 GB	1 x PCIe x16, 2 x PCI
UNO-348-A943A	Intel® Core™ i9-10900E 10-core CPU, Intel® H420E chipset, 16 GB RAM, 3 x COM, 6 x USB, 3 x LAN, 1 x PCIe x16, 2 x PCI	Intel® Core™ i9-10900TE		16 GB	
*UNO-348-ANN3A	Intel® H420E chipset, 3 x COM, 6 x USB, 3 x LAN, 1 x PCIe x16, 2 x PCI	Optional. (Supports Intel® Core™ i9/i7/i5/i3/ Celeron®/Pentium®)		Optional support up to 64 GB	

*For this model, the processor and RAM memory must be ordered separately.

Optional Expansion

PCIe/PCI Backplane (for UNO-348-AXX3A)

- **9893UR05000** 1 x PCIe x16, 2 x PCIe x1

RAM

- **SQR-SD4N8G3K2SNBCB** SODIMM DDR4 3200 8GB 1024x8 (0-85) SAM-C
- **SQR-SD4N16G3K2SNCB** SODIMM DDR4 3200 16GB 1024x8 (0-85) SAM-C
- **SQR-SD4N32G3K2SNAB** SODIMM DDR4 3200 32GB 2Gx8 (0-85) SAM-A

iDoor Module

Please purchase an additional iDoor PCIe I/O plate for iDoor module installation.

- **PCM-28P1BK-AE** iDoor PCIe I/O plate

Note:

1. The iDoor I/O plate will occupy one of PCIe/PCI slot
2. Contact Advantech information about supported iDoor modules.

GPIO cable

- **1700030635-01** D-SUB 9Pin GPIO cable 15cm

Note: Need to swap 1 x RS-232 to GPIO

Optional Accessories

Power Supply

- **96PSA-A230W24P4-3** ADP A/D 100 ~ 240V 230W 24V C14 4P terminal block

Power Cable

- **1702002600** Power cable (USA) UL/CSA, 3-pin, 10A, 125V, 1.83M
- **1702002605** Power cable (EU), 3-pin, 10A, 250V, 1.83M
- **1700000596** Power cable CCC, 3-pin, 10A, 250V, 1.83M

Embedded O/S

- TBD

Caution: If the system is equipped with optional modules, additional certificates may be required in certain regions/countries. Contact Advantech for certification compliance.